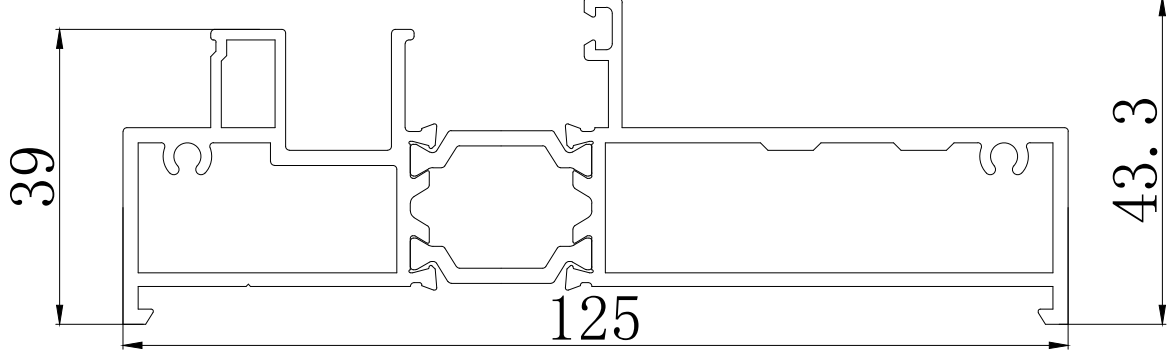
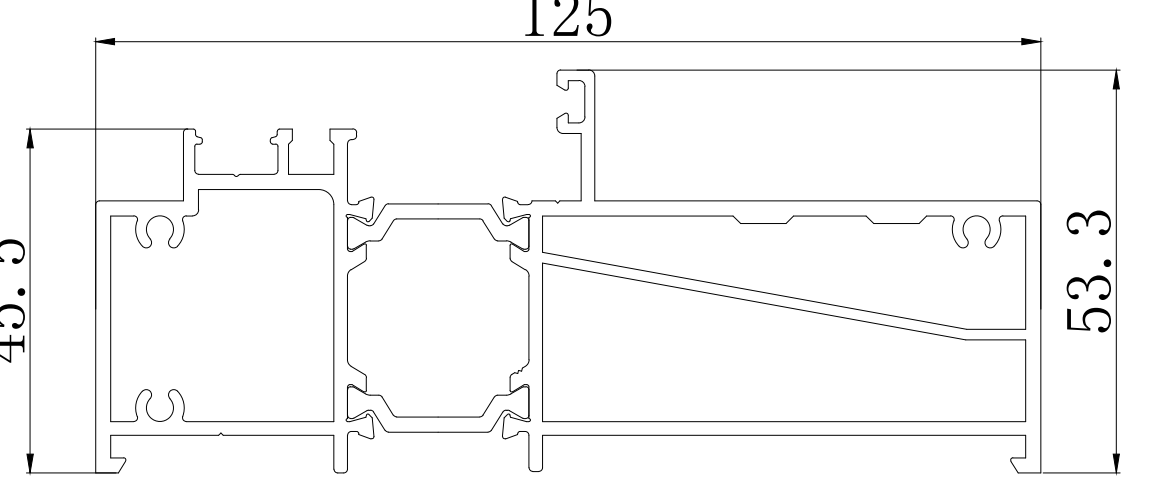
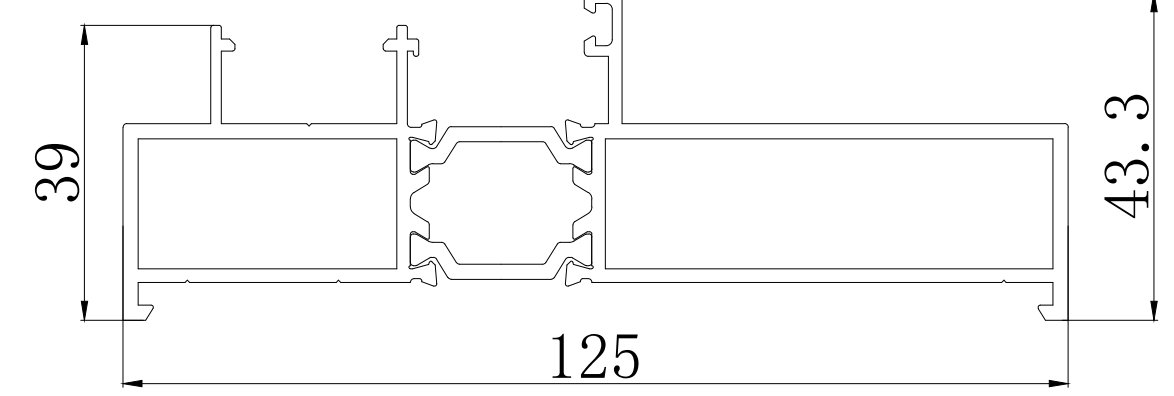
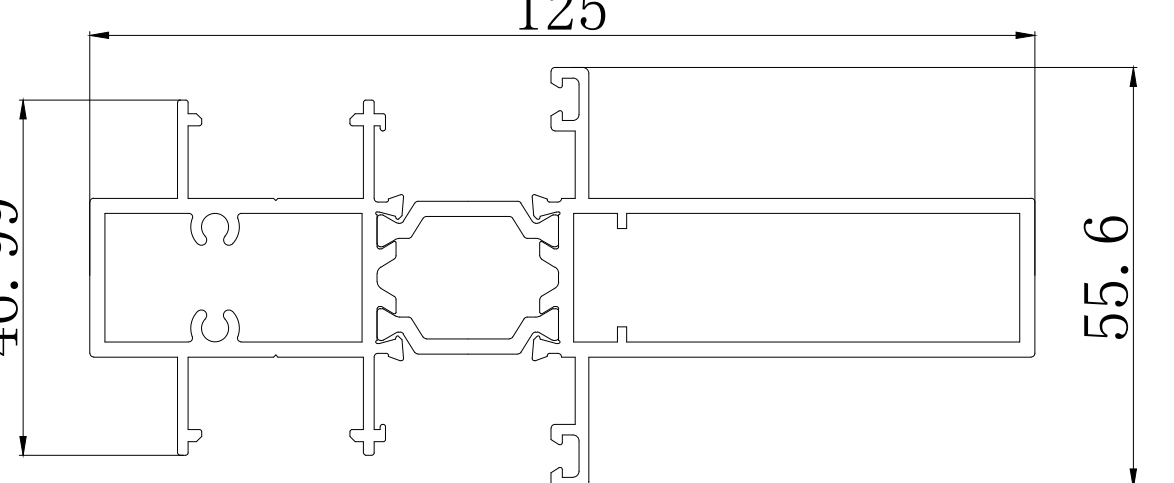
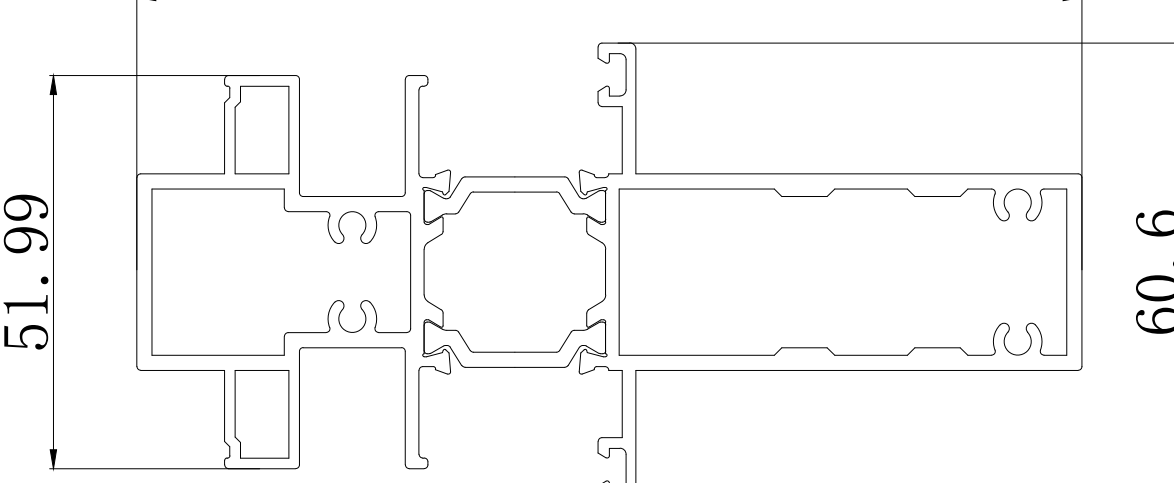
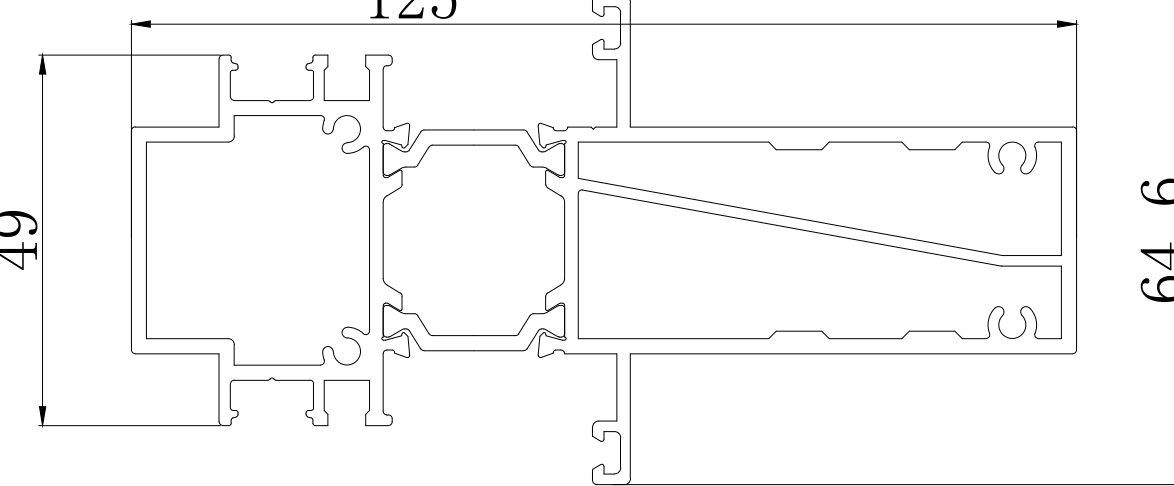
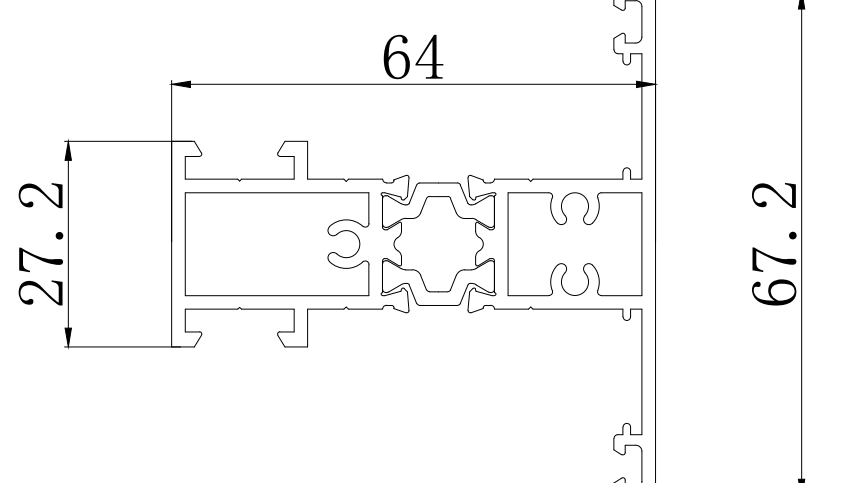
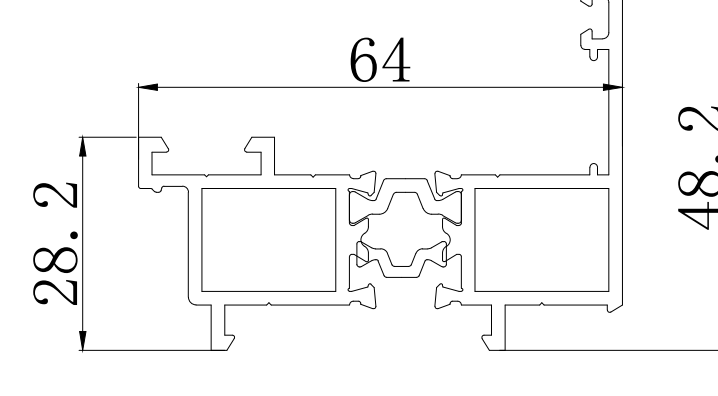
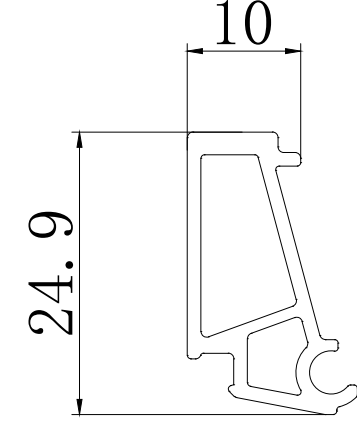
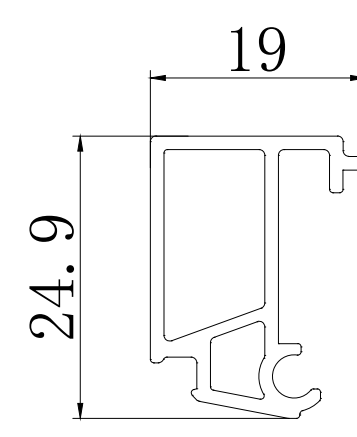
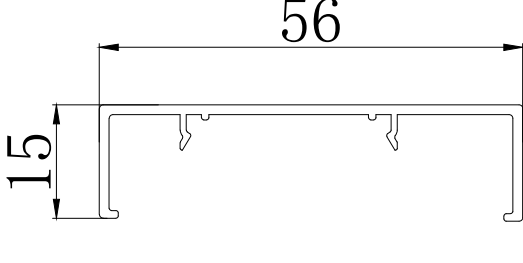
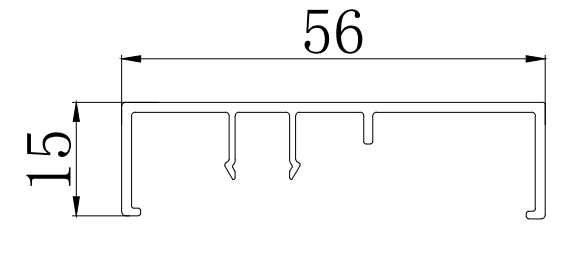
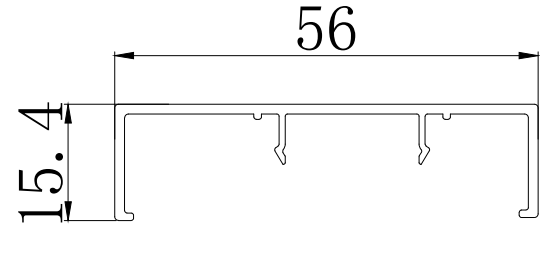
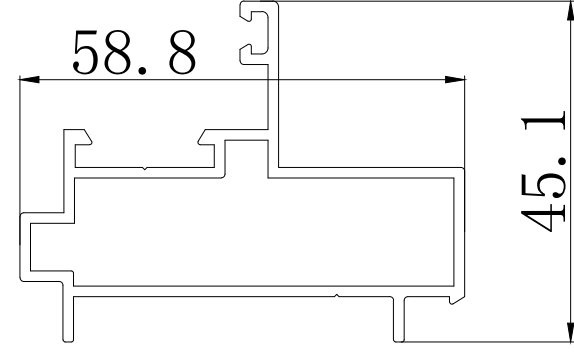
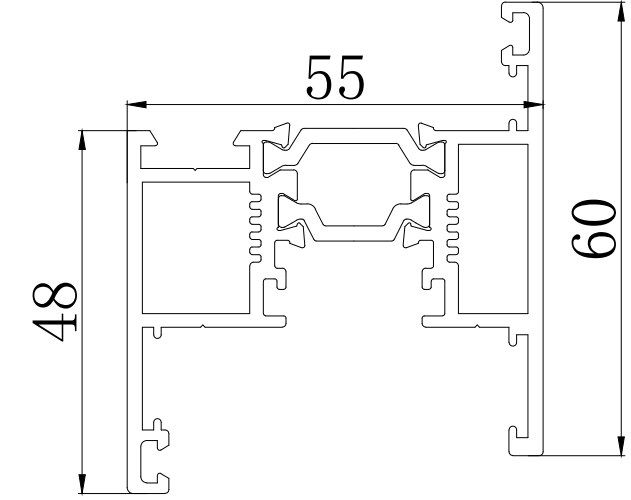
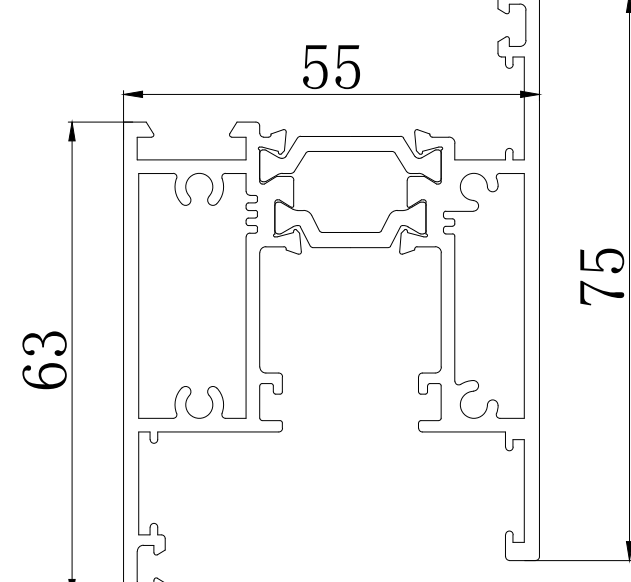
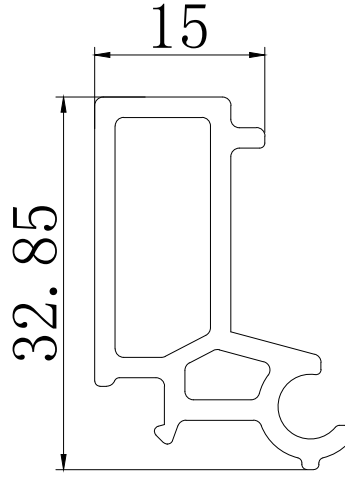
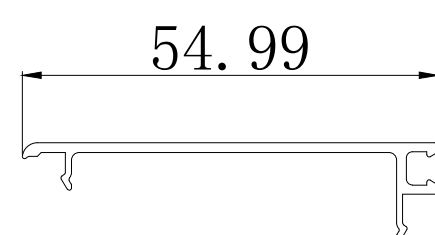
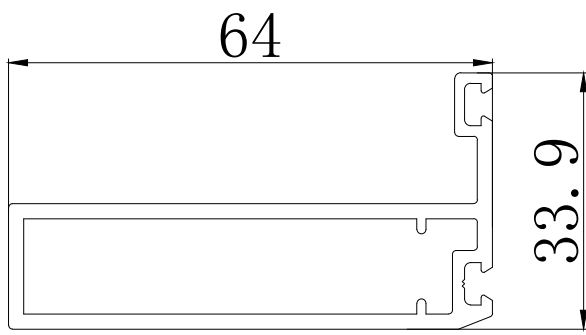
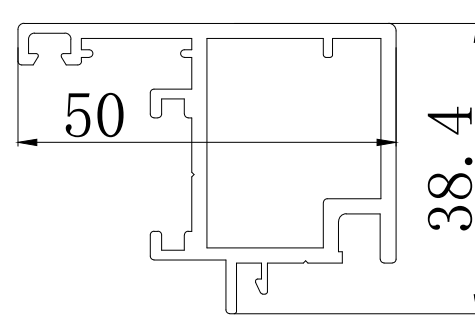
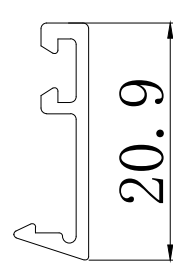
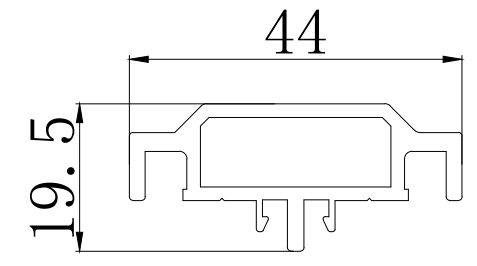
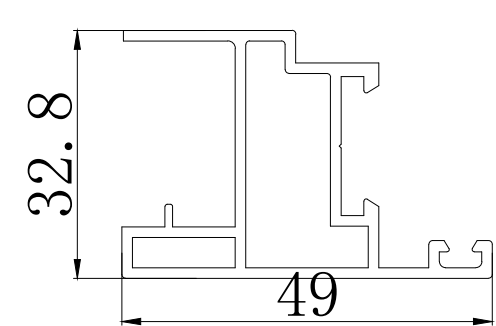
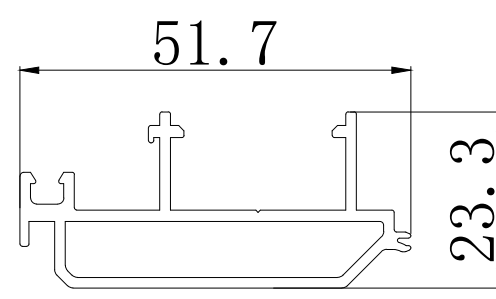
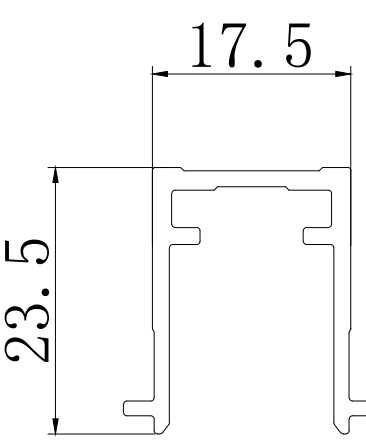
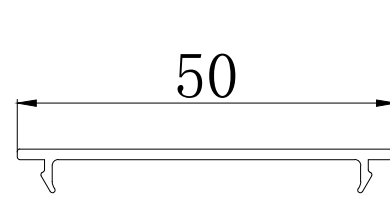
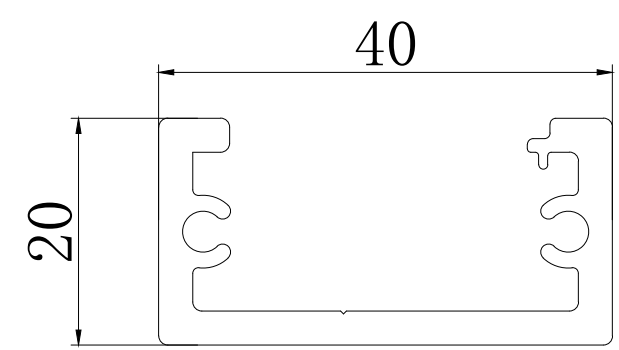

型号	名称	型材图	隔热条 (mm)	壁厚 (mm)	米重 (kg/m)	长度 (m)
框料						
ZS-SG-XZ001	上轨	 ZS-SG-XF002B ZS-SG-XF001A	24	2.0	2.19	6.5
ZS-XG-XZ002	下轨	 ZS-XG-XF004B ZS-XG-XF003A	24	2.0	2.66	6.5
ZS-BK-XZ003	边框	 ZS-BK-XF006B ZS-BK-XF005A	24	2.0	1.99	5.2
ZS-ZZ-XZ004	边固	 ZS-ZZ-XF008B ZS-ZZ-XF007A	24	2.0	2.30	5.2
ZS-SG-XZ034	上固定	 ZS-SG-XF095B ZS-SG-XF094A	24	2.0	2.73	6.5
ZS-XG-XZ035	下固定	 ZS-XG-XF097B ZS-XG-XF096A	24	2.0	2.88	6.5
ZS-ZZ-XZ036	中柱	 ZS-ZZ-XF099B ZS-ZZ-XF098A	14.8	1.8	1.58	6.0
ZS-BK-XZ007	固玻框	 ZS-BK-XF014B ZS-BK-XF013A	14.8	1.8	1.25	6.0
ZS-YX-XF018	大固玻压线			1.2	0.27	6.0
ZS-YX-XF019	小固玻压线			1.2	0.3	6.0
ZS-GB-XF021	上轨盖			1.3	0.33	6.0

型号	名称	型材图	隔热条 (mm)	壁厚 (mm)	米重 (kg/m)	长度 (m)
ZS-GB-XF022	下轨盖			1.3	0.35	6.0
ZS-GB-XF024	边封盖			1.3	0.33	5.2
ZS-SFK-XF025	纱扇框			1.4	0.78	6.0

型号	名称	型材图	隔热条 (mm)	壁厚 (mm)	米重 (kg/m)	长度 (m)
扇料						
ZS-BS-XZ005	光企	 ZS-BS-XF010B ZS-BS-XF009A	24 20	2.0	1.60	6.0
ZS-SXF-XZ006	下方	 ZS-SXF-XF012B ZS-SXF-XF011A	24 20	2.0	2.02	6.0
ZS-YX-XF017	扇玻压线			1.2	0.22	6.0
ZS-GB-XF560	光企装饰盖			1.3	0.26	5.2
ZS-GQ-XF557	勾企			2.0	0.98	5.2
ZS-SS-XF026	纱扇			2.0	0.90	6.0
21XT-023	纱压线			1.1	0.11	6.0
21XT-066	中横			1.8	0.61	6.0
AL-CS115-179	纱扇假中挺			1.4	0.7	6.0
ZS-SK-XF485	收口			1.5	0.61	5.2
ZS-GQ-XF029	滑轮传动杆			1.7	0.29	6.0

型号	名称	型材图	隔热条 (mm)	壁厚 (mm)	米重 (kg/m)	长度 (m)
ZS-FL-XF030	传动杆			1.6	0.14	6.0
辅料						
ZS-FL-XF031	加强中柱			2.5	1.14	5.2
ZS-FL-XF032	加强中柱盖			1.4	0.21	5.2
23-QJ-381	玻璃护栏			3.0	0.70	6.0
AL-LHZ-265	单色防护栏			1.1	0.30	3.0
ZS-FK-XF027	防护框			1.4	0.30	6.0
ZS-ZJ-XZ008	转角	 ZS-ZJ-XF016B ZS-ZJ-XF015A	24	1.6	2.54	6.0

一固一活+边固装配图

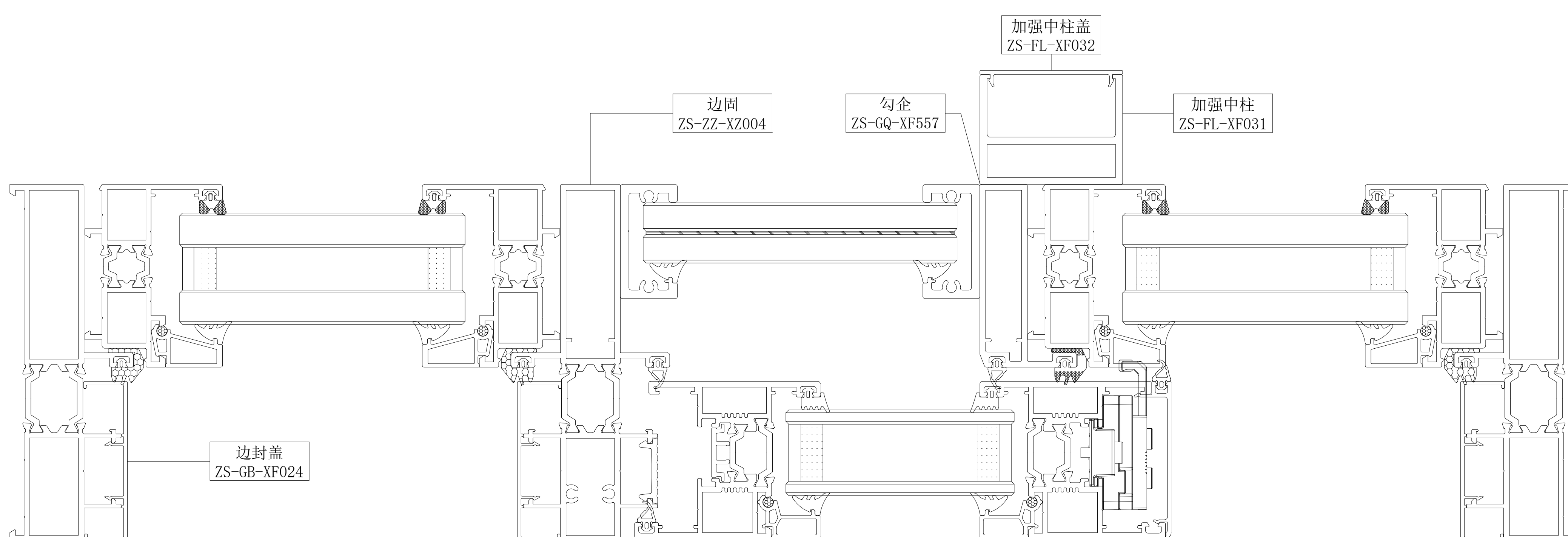
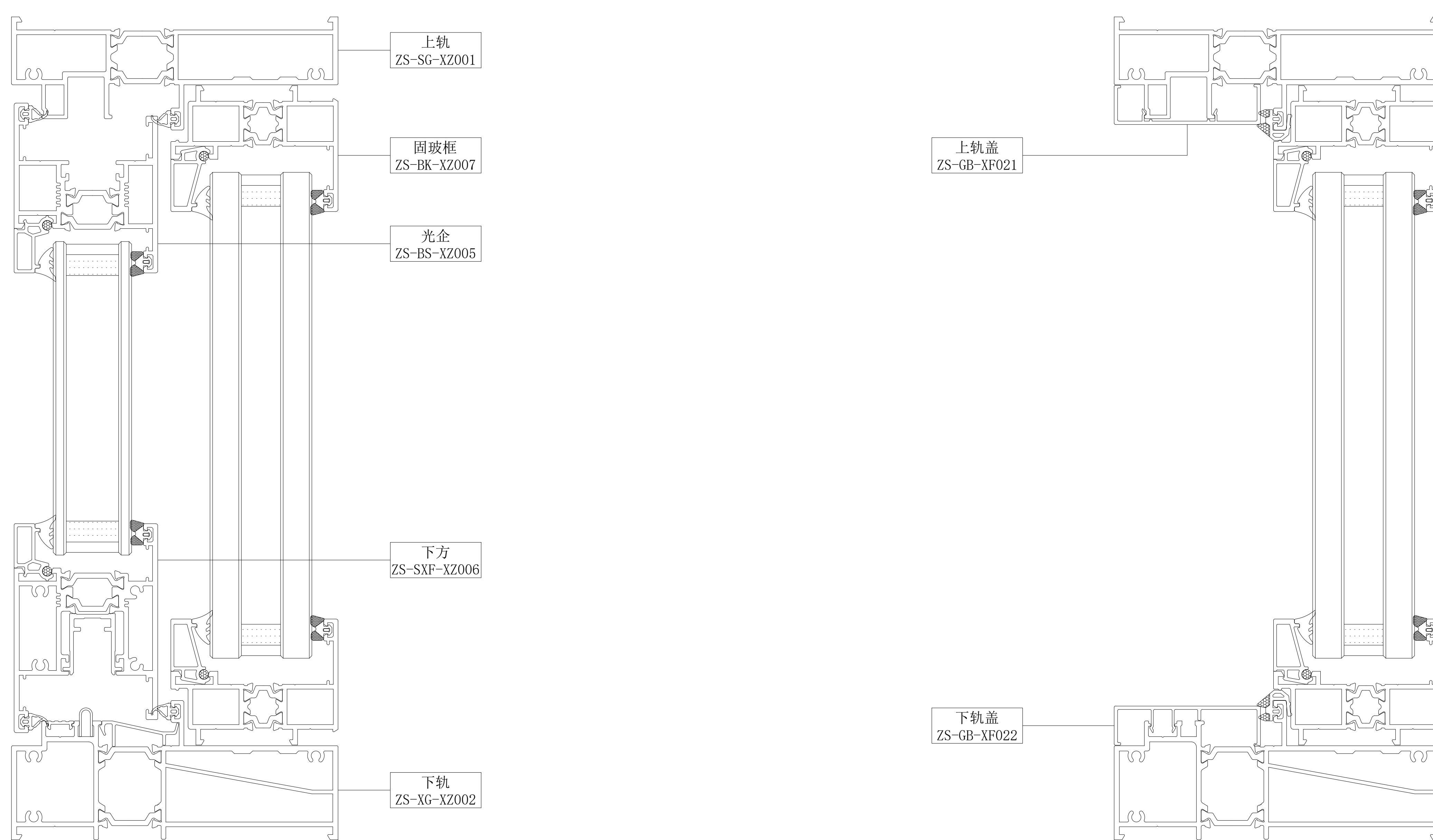

一固一活带上固装配图

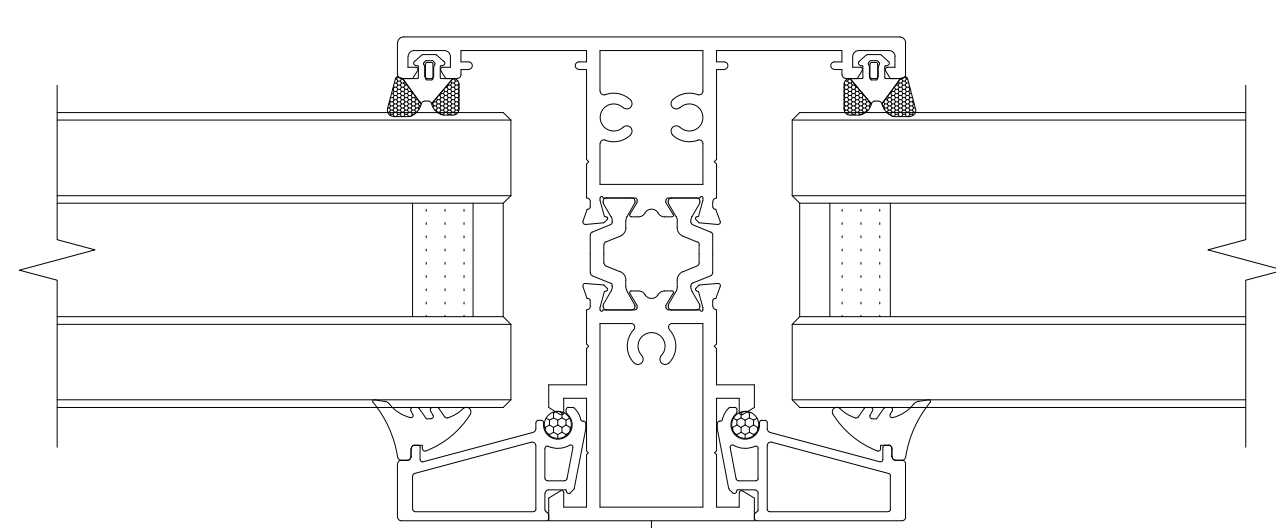
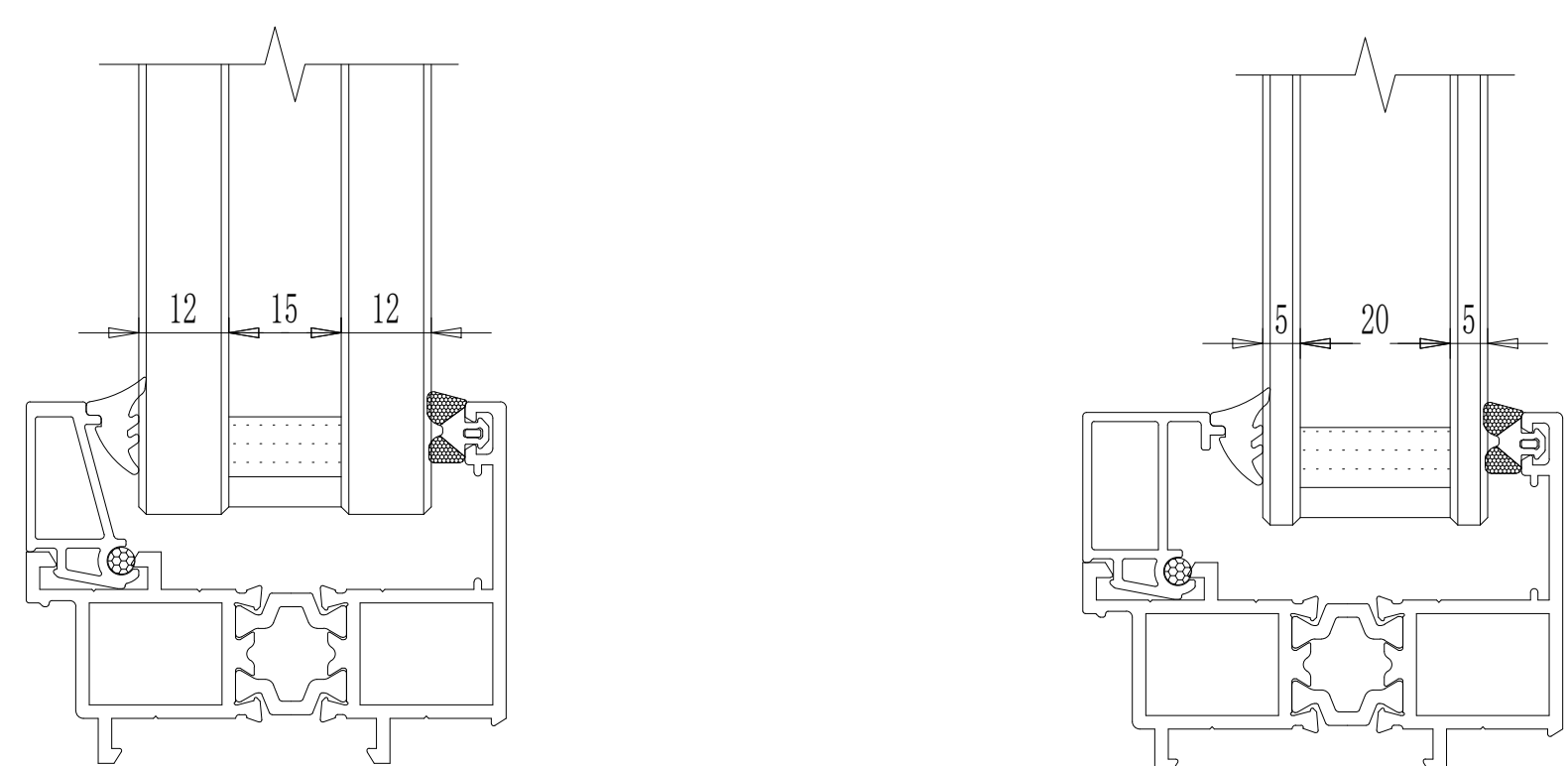

固玻中柱
ZS-ZZ-YZ036

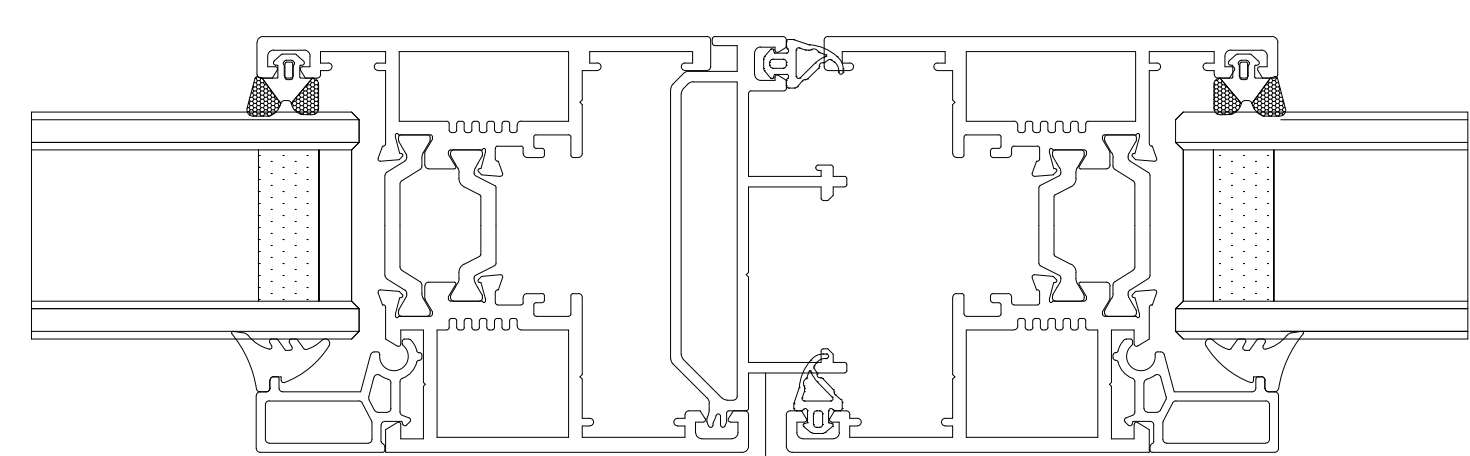

收口
ZS-SK-XP485

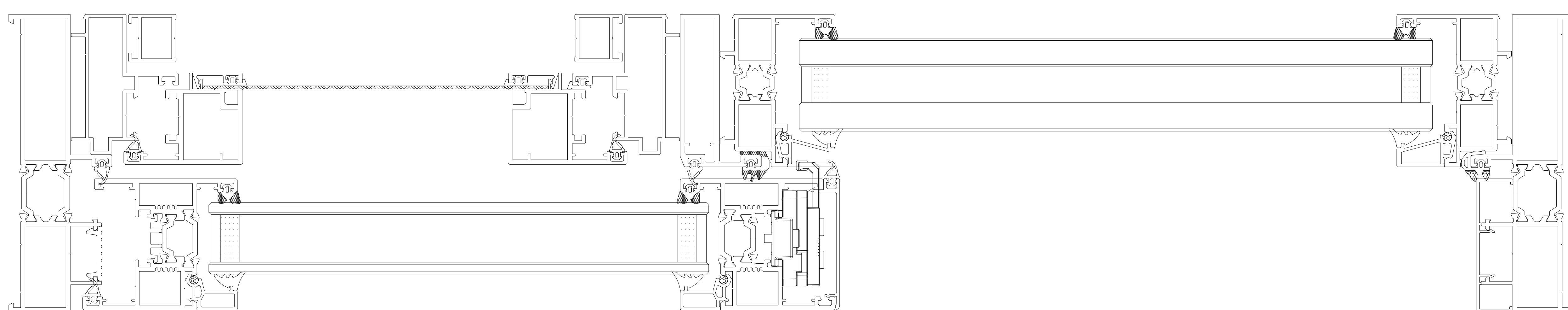
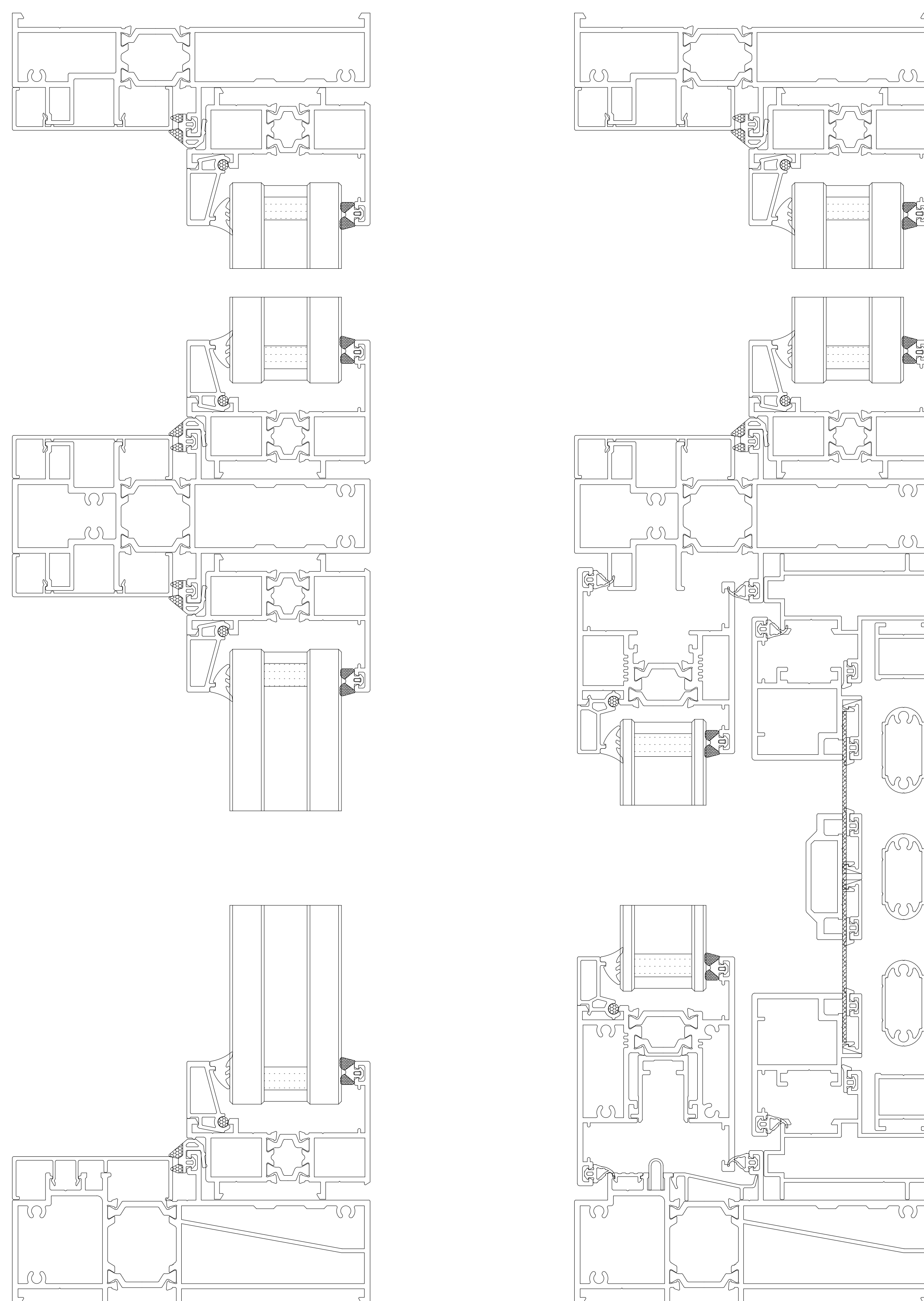

两活一固装配图

